

Steeple #1

figure - 1

DESIGN PARAMETERS

The unit described in these drawings is engineered to adequately support the loads created by a wind velocity of 120 MPH at a height of 50 feet above ground using ACSCE 7-95 exposure category "C". An additional 2 feet in height was added to the base during these calculations to account for variations in roof pitch, etc.

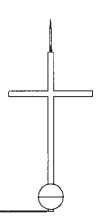
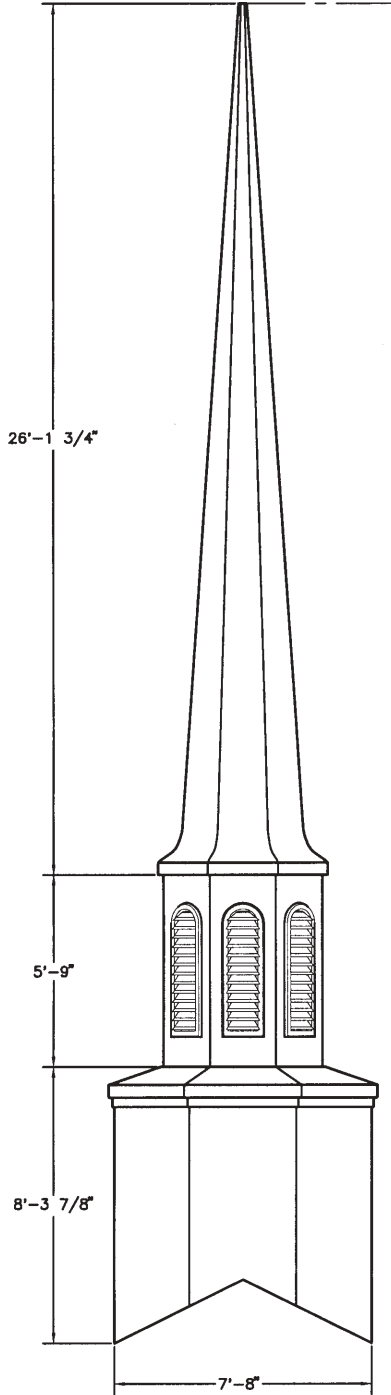

OPTIONAL LIGHTNING PROTECTION AIR TERMINAL

OPTIONAL 4' SPIRE CROSS (ALSO AVAILABLE IN 2' AND 3' HEIGHTS).

OPTIONAL 9" DIAMETER BALL (ALSO AVAILABLE IN 6" DIAMETER)

ALL UNITS WERE ENGINEERED WITH A 4' CROSS AND 9"Ø BALL INSTALLED PER FIBERGLASS SPECIALTIES, INC. STANDARD MOUNTING PROCEDURES.

SPIRE UNIT #728

CUPOLA UNIT #701 WITH VENTED LOUVERS (ALSO AVAILABLE WITH FALSE LOUVERS AND KRINKLGLAS® WINDOWS)

BASE CUPOLA UNIT #704

12
? SPECIFY ROOF PITCH & STYLE

1 ELEVATION
E1

Dimensions and details are subject to change without notice. All cupola and steeple units are fabricated using minimal standing seams unless otherwise noted. All cupola and steeple units are designed to be erected on a completed roofing system and are not guaranteed to be leak proof.

Steeple #1

figure - 2

DESIGN PARAMETERS
 The unit described in these drawings is engineered to adequately support the loads created by a wind velocity of 120 MPH at a height of 50 feet above ground using ACSCE 7-95 exposure category "C". An additional 2 feet in height was added to the base during these calculations to account for variations in roof pitch, etc.

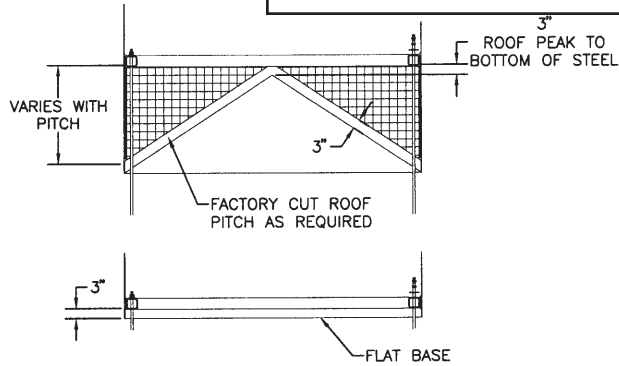

5 BASE DETAILS
 S1

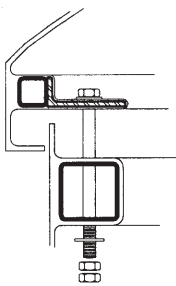

4 BOLTING DETAIL
 S1

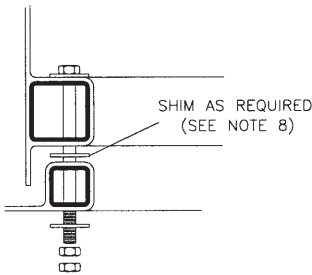

3 BOLTING DETAIL
 S1

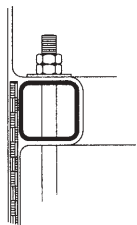

2 ANCHOR DETAIL
 S1

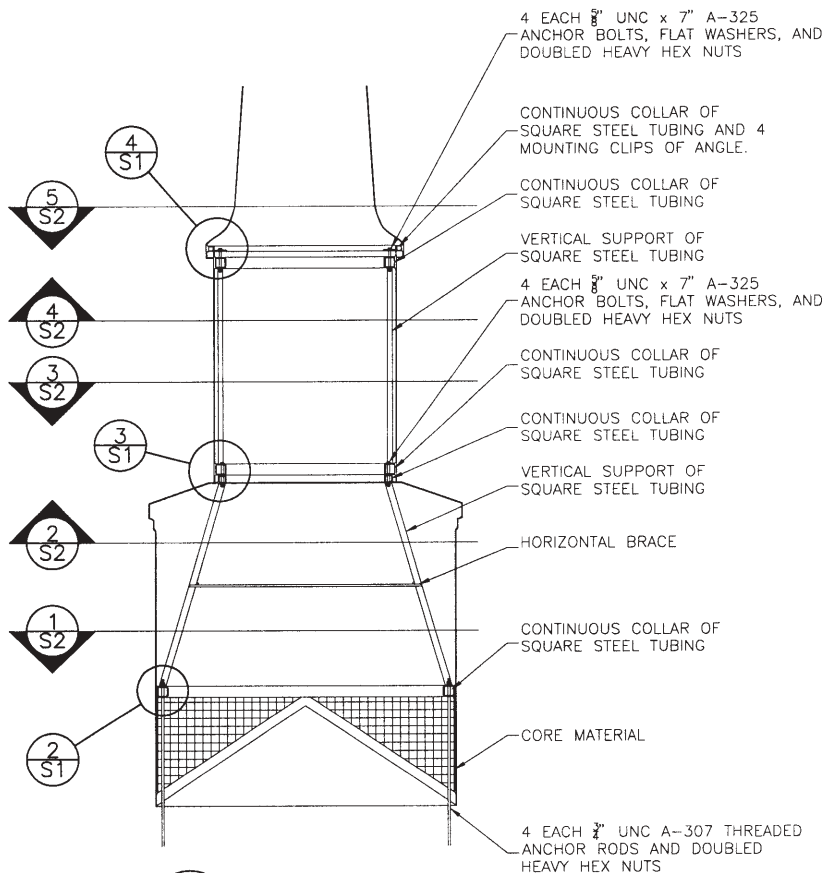

1 FULL SECTION
 S1

Dimensions and details are subject to change without notice. All cupola and steeple units are fabricated using minimal standing seams unless otherwise noted. All cupola and steeple units are designed to be erected on a completed roofing system and are not guaranteed to be leak proof.

Steeple #1

figure - 3

DESIGN PARAMETERS

The unit described in these drawings is engineered to adequately support the loads created by a wind velocity of 120 MPH at a height of 50 feet above ground using ACSCE 7-95 exposure category "C". An additional 2 feet in height was added to the base during these calculations to account for variations in roof pitch, etc.

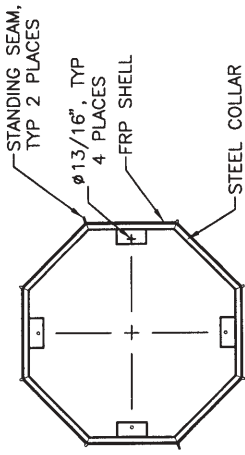

5 BASE OF SP-728
PLAN VIEW
S2

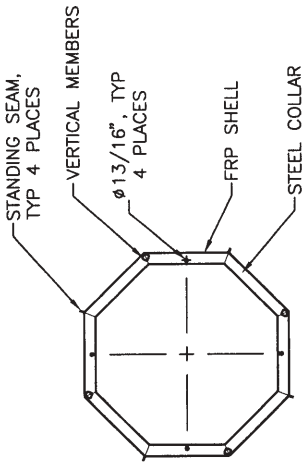

4 TOP OF CU-701
REFLECTED VIEW
S2

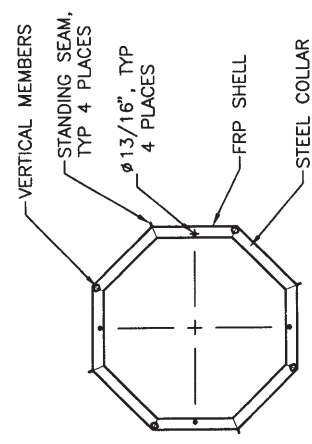

3 BASE OF CU-701
PLAN VIEW
S2

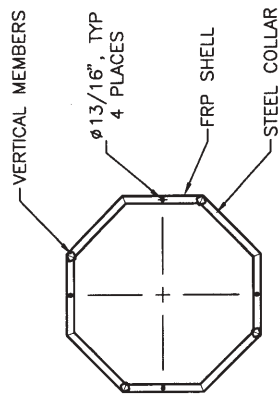

2 TOP OF CU-704
REFLECTED VIEW
S2

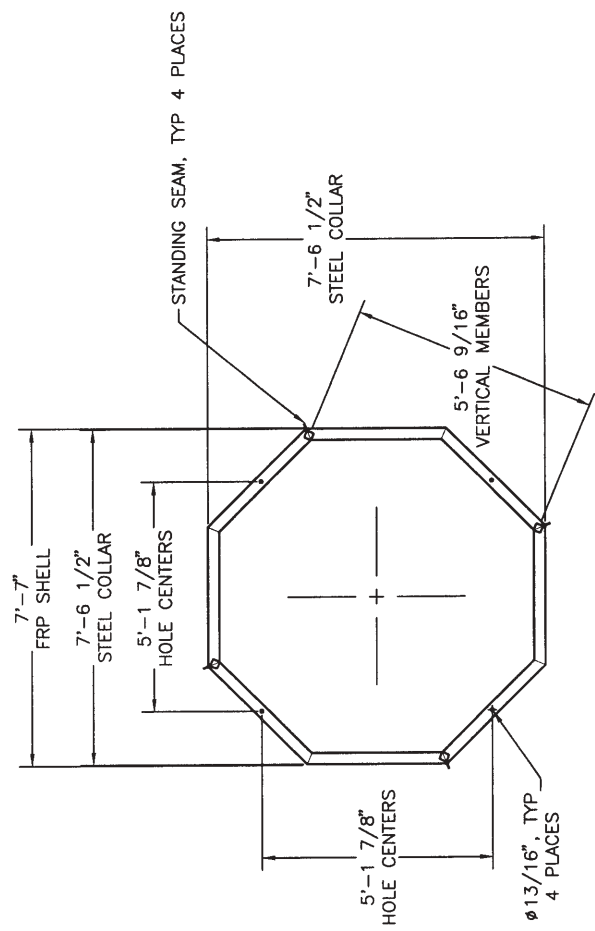

1 BASE OF CU-704
PLAN VIEW
S2